



SHANYI
STEEL IBÉRICA

BARANDILLAS DE ACERO QUE LLEVAN
TU ESPACIO AL SIGUIENTE NIVEL.



CATÁLOGO 2023 / 2024



NOVEDAD

COLOREADO ELECTROLÍTICO

- ✓ Un efecto de color único, ya que no utiliza ningún tipo de pintura o pigmento.
- ✓ No se degrada por los rayos UV.
- ✓ No requiere mantenimiento.

La película superficial de óxido de cromo que hace que el acero inoxidable sea resistente es transparente. Su grosor de unos pocos átomos deja pasar la luz sin problemas. Pero si vamos a aumentar la profundidad de esta capa superficial, se crean fenómenos de interferencia que filtran los rayos de luz. Ciertas longitudes de onda son absorbidas y otras son reflejadas, creando típicos efectos de colores. Un fenómeno similar se observa en las burbujas de jabón o manchas de aceite. Al cambiar el ángulo el color parece variar.

ÍNDICE

3	PILARES RANURADOS
4	PINZAS SUELO VIDRIO TEMPLADO
6	PINZAS SUELO VIDRIO CON GOMAS
8	PINZAS TUBO O PARED PARA VIDRIO
10	SOPORTES FIJACIÓN PARED
13	SOPORTES PASAMANOS
14	CONECTORES
15	SOPORTES PARA TUBOS TENSORES PARA CABLE
16	TAPAS PARA TUBOS VARILLAS
17	SOPORTES PASAMANOS
18	PASADORES SOPORTES LATERALES
19	PLACAS FIJACIÓN Y VALONAS
20	VALONAS PERFILES ALUMINIO



Pilares ranurados

CADA PILAR SE SIRVE CON SU CANAL INTERNO PARA EL VIDRIO.

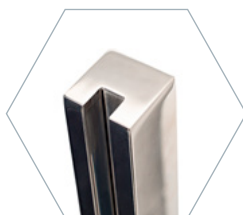

| PILAR DE 1 CANAL

MEDIDAS EN MM

CÓDIGO	CUADRADO	ALTURA	ACABADO	VIDRIO
SS-901	40 x 40	1000	Pulido	10
SS-902	40 x 40	1000	Pulido	12
SS-903	40 x 40	1000	Satinado	10
SS-904	40 x 40	1000	Satinado	12



| PILAR DE 2 CANALES

MEDIDAS EN MM

CÓDIGO	CUADRADO	ALTURA	ACABADO	VIDRIO
SS-905	40 x 40	1000	Pulido	10
SS-906	40 x 40	1000	Pulido	12
SS-907	40 x 40	1000	Satinado	10
SS-908	40 x 40	1000	Satinado	12

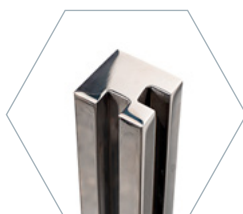

| PILAR DE 2 CANALES ESQUINERO

MEDIDAS EN MM

CÓDIGO	CUADRADO	ALTURA	ACABADO	VIDRIO
SS-909	40 x 40	1000	Pulido	10
SS-910	40 x 40	1000	Pulido	12
SS-911	40 x 40	1000	Satinado	10
SS-912	40 x 40	1000	Satinado	12

Se fabrican sobre pedido a medida. Plazo de entrega 10-12 días.

Pinzas para vidrio templado

| FIJACIÓN SUELO - CON TALADRO A VIDRIO



CÓDIGO	SS-3010
MEDIDA	40x40x300
VIDRIO	12 mm
ACABADO	Pulido 304

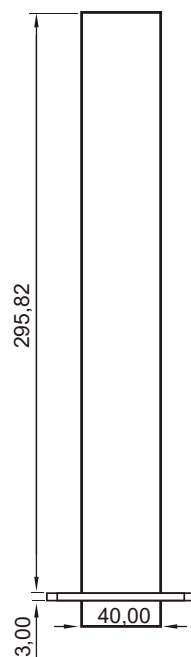
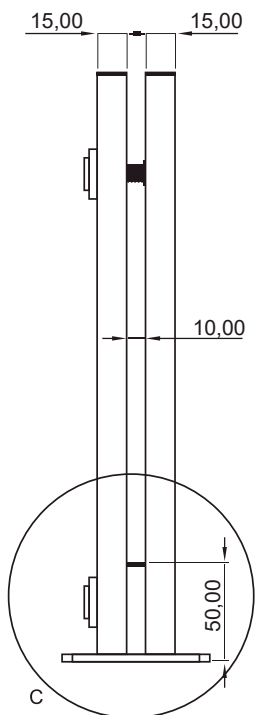
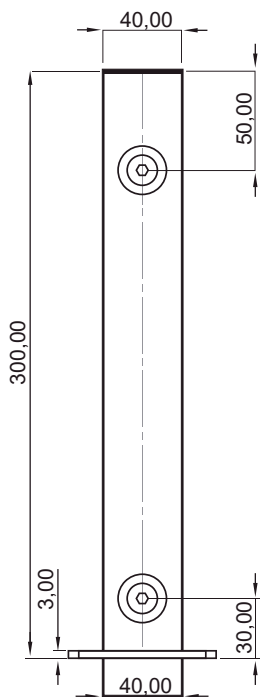



Pinzas para vidrio con gomas

| FIJACIÓN SUELO - SIN TALADRO A VIDRIO
VALONA INCLUIDA CUADRADA



PULIDO

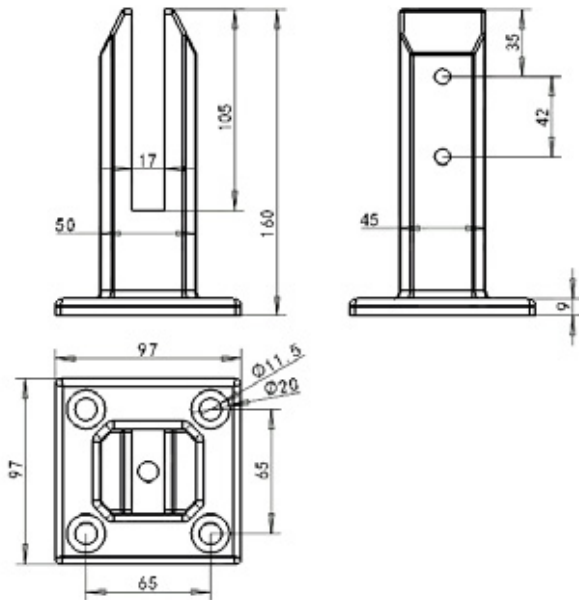

CÓDIGO	VIDRIO (mm)	CANTIDAD
SS-1303	12,76	1



NOVEDAD

Coloreado electrolítico



PULIDO ORO ROSA



CÓDIGO	VIDRIO (mm)	CANTIDAD
SS-1302/OR	12,76	1

PULIDO ORO



CÓDIGO	VIDRIO (mm)	CANTIDAD
SS-1302/O	12,76	1

| VALONA INCLUIDA REDONDA

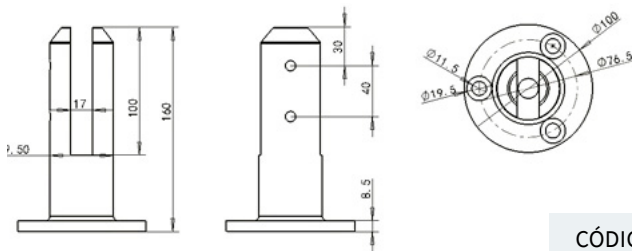

CÓDIGO	VIDRIO (mm)	CANTIDAD
SS-1302	12,76	1

| SIN VALONA



CÓDIGO	VIDRIO (mm)	CANTIDAD
SS-1301	12,76 - 17,52	1

Pinzas para vidrio

| FIJACIÓN TUBO REDONDO

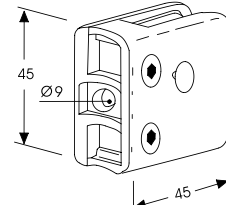
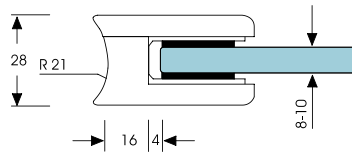

MEDIDAS EN MM

CÓDIGO	TUBO	ACABADO	VIDRIO	MEDIDA	CALIDAD	CANTIDAD
SS-1304	43	Pulido	8,76/10,76	45x45x28	AISI-316	4
SS-1305	43	Satinado	8,76/10,76	45x45x28	AISI-304	4

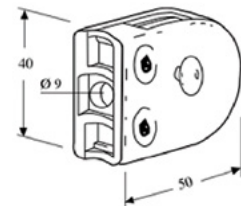
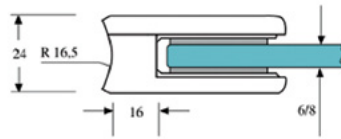

MEDIDAS EN MM

CÓDIGO	TUBO	ACABADO	VIDRIO	MEDIDA	CALIDAD	CANTIDAD
SS-1307	43	Pulido	8,76/10,76	50X40X26	AISI-316	4
SS-1308	43	Satinado	8,76-/0,76	50X40X26	AISI-304	4
SS-1309	50,8	Pulido	10,76/12,76	63X46X28	AISI-316	4

| FIJACIÓN TUBO CUADRADO O PARED

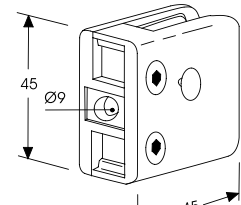
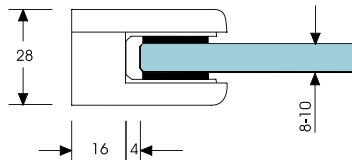

MEDIDAS EN MM

CÓDIGO	TUBO	ACABADO	VIDRIO	MEDIDA	CALIDAD	CANTIDAD
SS-1310	PLANO	Pulido	8,76/10,76	45x45x28	AISI-316	4
SS-1311	PLANO	Satinado	8,76/10,76	45x45x28	AISI-304	4

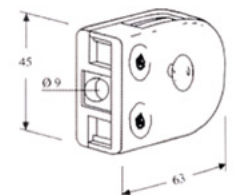
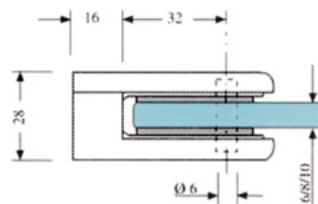

MEDIDAS EN MM

CÓDIGO	TUBO	ACABADO	VIDRIO	MEDIDA	CALIDAD	CANTIDAD
SS-1313	PLANO	Pulido	8,76/10,76	50X40X26	AISI-316	4
SS-1314	PLANO	Satinado	8,76/10,76	50X40X26	AISI-304	4
SS-1315	PLANO	Pulido	10,76/12,76	63X46X28	AISI-316	4

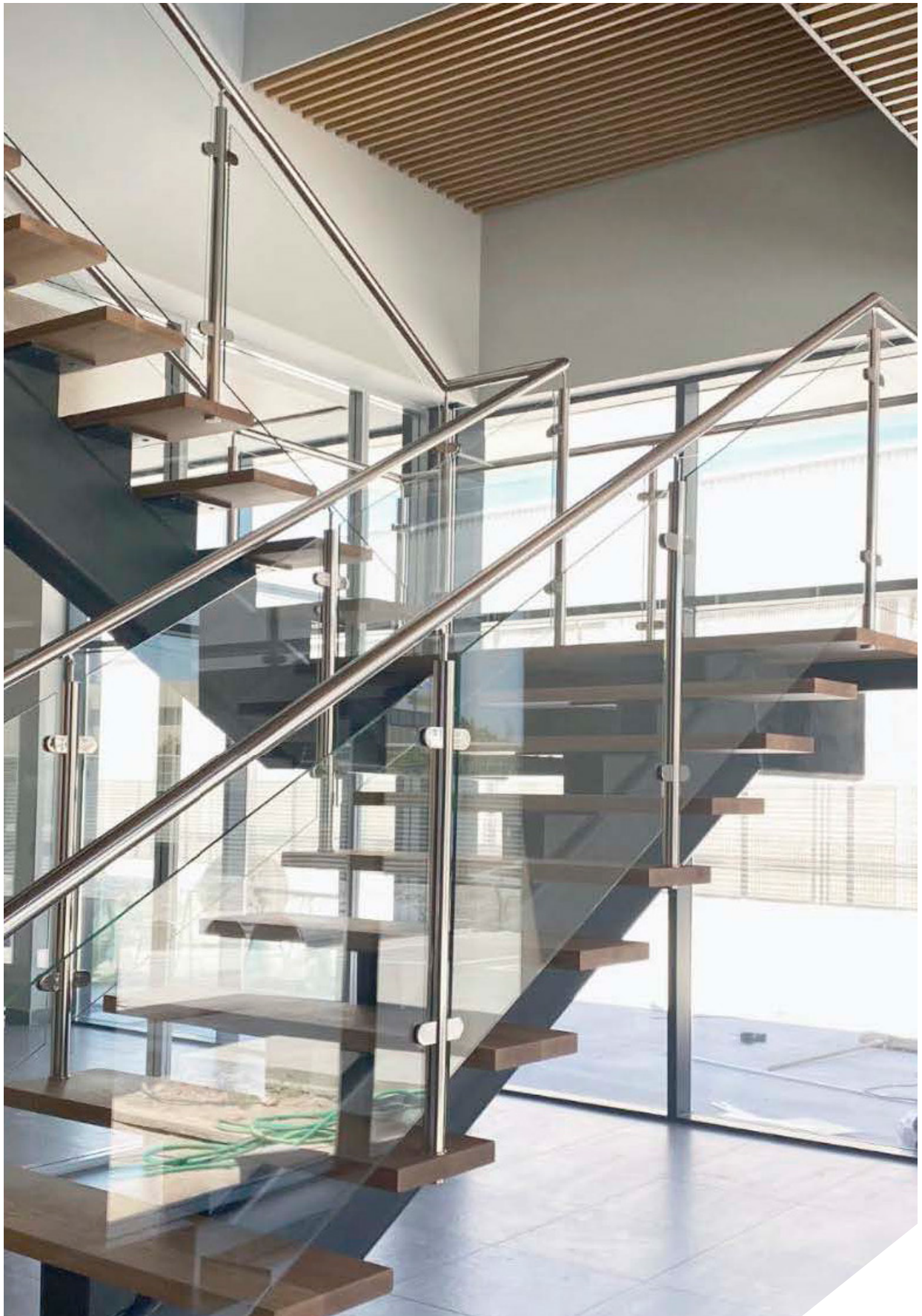

Soportes fijación pared

| SOPORTE REDONDO CON REGULACIÓN



PULIDO

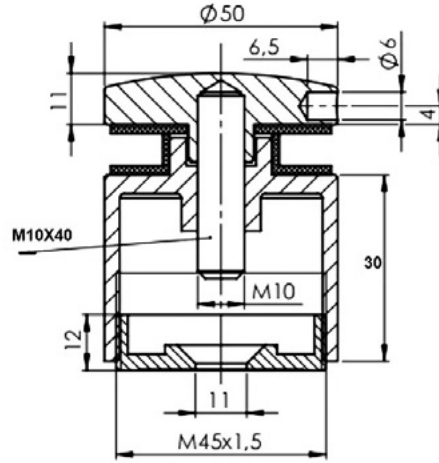

MEDIDAS EN MM		
CÓDIGO	VIDRIO	CANTIDAD
SS-1316	8/16	4



PULIDO ORO ROSA



MEDIDAS EN MM		
CÓDIGO	VIDRIO	CANTIDAD
SS-1316/OR	8/16	4

PULIDO ORO



MEDIDAS EN MM		
CÓDIGO	VIDRIO	CANTIDAD
SS-1316/O	8/16	4

| SOPORTE CUADRADO PARA VIDRIO



MEDIDAS EN MM		
CÓDIGO	VIDRIO	CANTIDAD
SS-1317	8/16	3

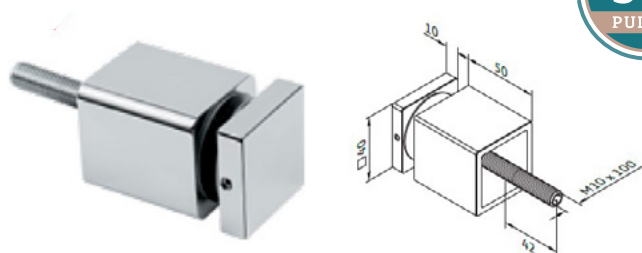



Soportes pasamanos



| PARA PILAR Y TUBO REDONDO



CÓDIGO	TUBO	MEDIDAS EN MM
		CANTIDAD
SS-1401	43 x 1,5	4

- INCLINACIÓN REGULABLE



CÓDIGO	TUBO	MEDIDAS EN MM
		CANTIDAD
SS-1402	43 x 1,5	4

| PARA PILAR CUADRADO Y TUBO REDONDO

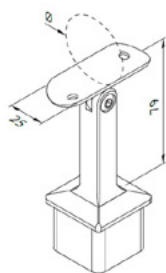

CÓDIGO	TUBO	MEDIDAS EN MM
		CANTIDAD
SS-1403	40 x 40 x 1,5 - 2	2

- INCLINACIÓN REGULABLE

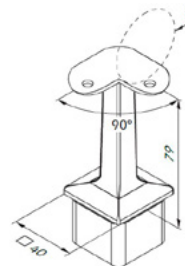

CÓDIGO	TUBO	MEDIDAS EN MM
		CANTIDAD
SS-1404	40 x 40 x 1,5 - 2	4

| PARA PILAR CUADRADO Y TUBO PLANO

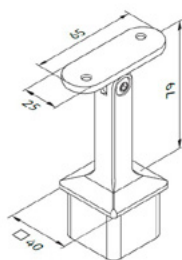

CÓDIGO	TUBO	MEDIDAS EN MM
		CANTIDAD
SS-1405	40 x 40 x 1,5 - 2	2

- INCLINACIÓN REGULABLE

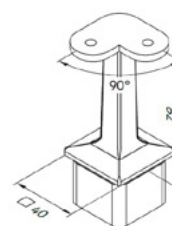

CÓDIGO	TUBO	MEDIDAS EN MM
		CANTIDAD
SS-1406	40 x 40 x 1,5 - 2	4





Conectores

| PARA TUBO REDONDO

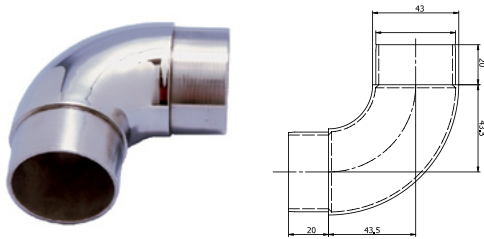

MEDIDAS EN MM

CÓDIGO	TUBO	CANTIDAD
SS-1407	43 x 1,5	4

| PARA TUBO CUADRADO

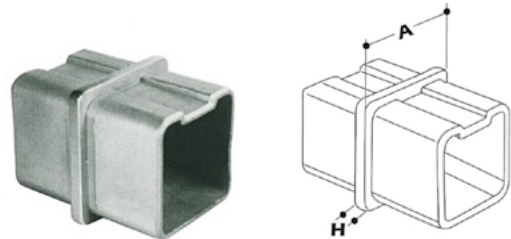

MEDIDAS EN MM

CÓDIGO	A	H	CANTIDAD
SS-1410	40x40x1,5- 2	4	4

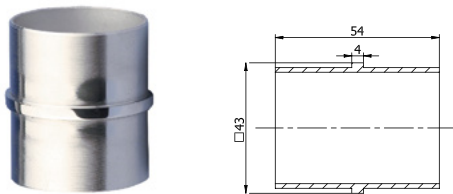

MEDIDAS EN MM

CÓDIGO	TUBO	CANTIDAD
SS-1408	43 x 1,5	4

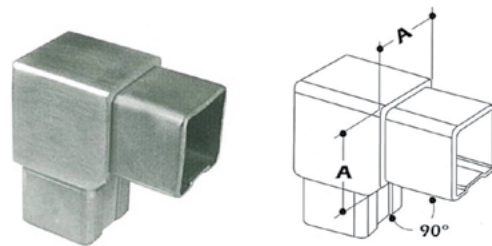

MEDIDAS EN MM

CÓDIGO	A	H	CANTIDAD
SS-1411	40x40x1,5- 2	4	4

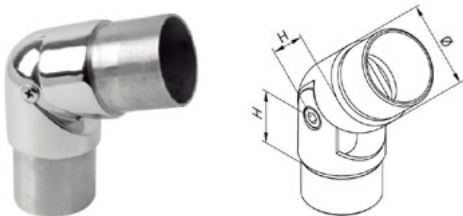

MEDIDAS EN MM

CÓDIGO	TUBO	CANTIDAD
SS-1409	43 x 1,5	4

- ARTICULADO REGULABLE A 90° - 180°

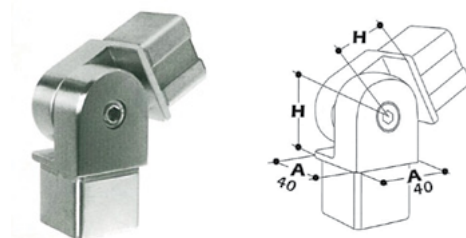

MEDIDAS EN MM

CÓDIGO	A	H	CANTIDAD
SS-1412	40x40x1,5- 2	26	4

- ARTICULADO REGULABLE A 90° - 180°

Soportes para tubo



| SOPORTE BASE CON TALADROS AVELLANADOS PARA TUBO REDONDO



CÓDIGO	DIÁMETRO	CANTIDAD
SS-1703	43 - 50,8	10

| SOPORTE BASE ESCUADRA 90° PARA TUBO REDONDO

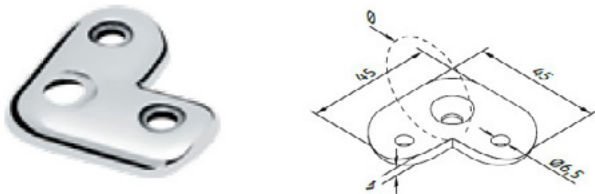

CÓDIGO	DIÁMETRO	CANTIDAD
SS-1704	43 - 50,8	10

| SOPORTE BASE CON TALADROS AVELLANADOS PARA TUBO PLANO

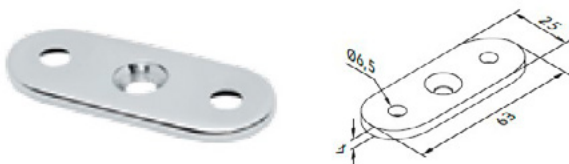

CÓDIGO	CANTIDAD
SS-1705	10

| SOPORTE BASE ESCUADRA 90° PARA TUBO PLANO

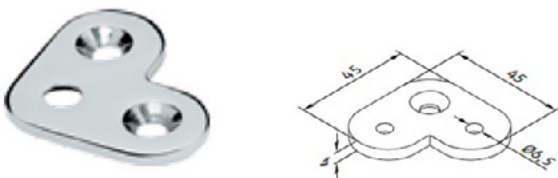

CÓDIGO	CANTIDAD
SS-1706	10

Tensores para cables



| TENSOR PRINCIPAL



CÓDIGO	PARA CABLE	CANTIDAD
SS-1901	4 y 5 mm	10

| TENSOR TERMINAL

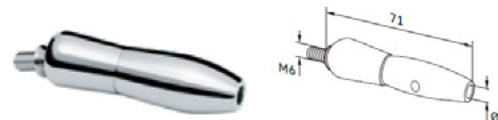

CÓDIGO	PARA CABLE	CANTIDAD
SS-1902	4 y 5 mm	10

| BOBINA DE CABLE
DE 4-5 MM - 7 X 19

CÓDIGO	CANTIDAD
SS-1903	4 mm x 100 m
SS-1904	5 mm x 100 m

Tapas para tubo



MEDIDAS EN MM		
CÓDIGO	MEDIDA	CANTIDAD
SS-1512	12 x 1,5	50
SS-1518	18 x 1,5	50
SS-1520	20 x 1,5	50
SS-1525	25 x 1,5	30
SS-1530	30 x 1,5	30
SS-1538	38 x 1,5	6
SS-1540	40 x 1,5	20
SS-1543	43 x 1,5	20
SS-1550	50,8 x 1,5	12

• FUNDICIÓN



MEDIDAS EN MM		
CÓDIGO	MEDIDA	CANTIDAD
SS-1555	43 x 1,5	4



MEDIDAS EN MM		
CÓDIGO	MEDIDA	CALIDAD
SS-1560	40x40x1,5	Pulido 316
SS-1560/S	40x40x1,5	Satinado 304
SS-1562	40x40x2	Pulido 316
SS-1562/S	40x40x2	Satinado 304
SS-1565	50x50x1,5	Pulido 316



MEDIDAS EN MM		
CÓDIGO	MEDIDA	CALIDAD
SS-1583	43x1,5	Pulido 316
SS-1583/S	43x1,5	Satinado 304

| TAPA FINAL CON TALADRO ROSCA M8



MEDIDAS EN MM		
CÓDIGO	MEDIDA	CANTIDAD
SS-1570	43 x 1,5	10

Varillas redondas con rosca M8

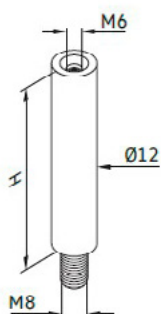

CÓDIGO	DIÁMETRO	H	CANTIDAD
SS-1701	12	68	15

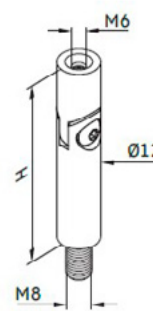

CÓDIGO	DIÁMETRO	H	CANTIDAD
SS-1702	12	68	15

• REGULABLE - ARTICULADO

Soportes para pasamanos



| PARA TUBO REDONDO 40-50,8 – FIJACIÓN A PARED

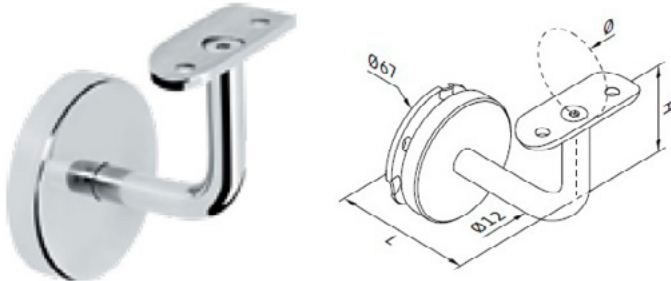

MEDIDAS EN MM			
CÓDIGO	L	H	CANTIDAD
SS-2101	70	65	4

• VALONA INCLUIDA

| SOPORTE UNIÓN DOBLE – FIJACIÓN A TUBO PLANO

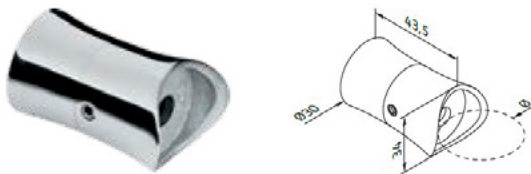

MEDIDAS EN MM				
CÓDIGO	DIÁMETRO	L	D	CANTIDAD
SS-2102	Plano - 43	51	31	12

| SOPORTE UNIÓN DOBLE – FIJACIÓN A TUBO REDONDO

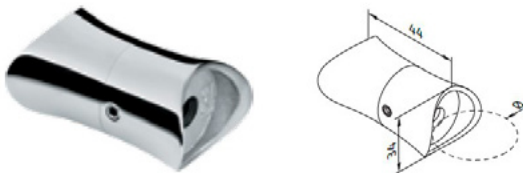

MEDIDAS EN MM				
CÓDIGO	DIÁMETRO	L	D	CANTIDAD
SS-2103	43 - 43	44	37	6
SS-2104	50,8 - 50,8	44	37	6

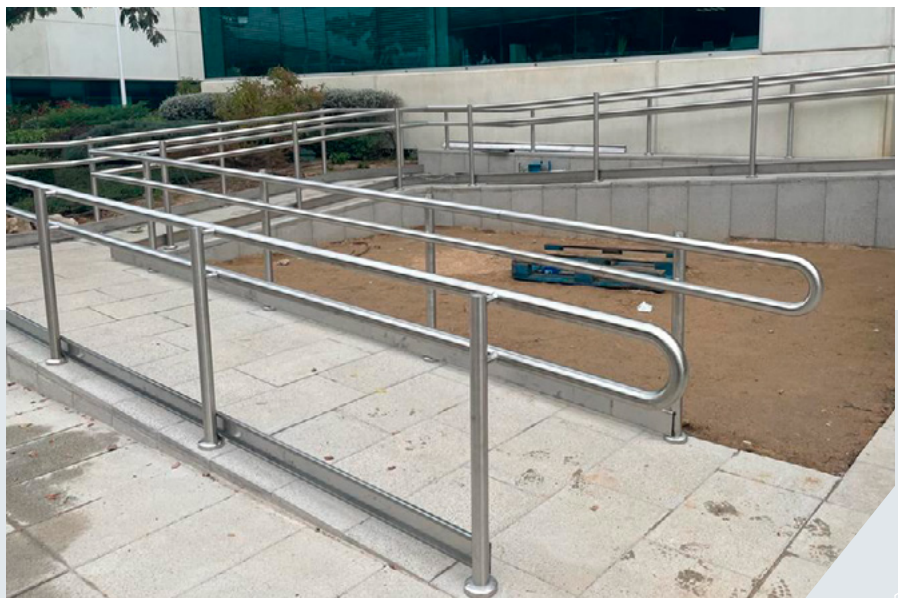

Pasadores

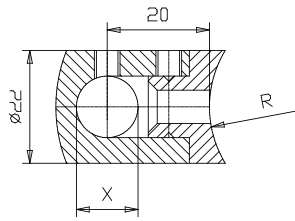

MEDIDAS EN MM

CÓDIGO	RADIO	MEDIDA	TALADRO	CANTIDAD
SS-2105	21	22	12	10

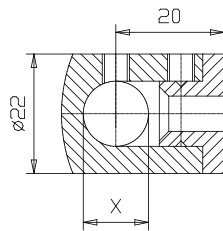

MEDIDAS EN MM

CÓDIGO	BASE	MEDIDA	TALADRO	CANTIDAD
SS-2106	PLANA	22	12	10

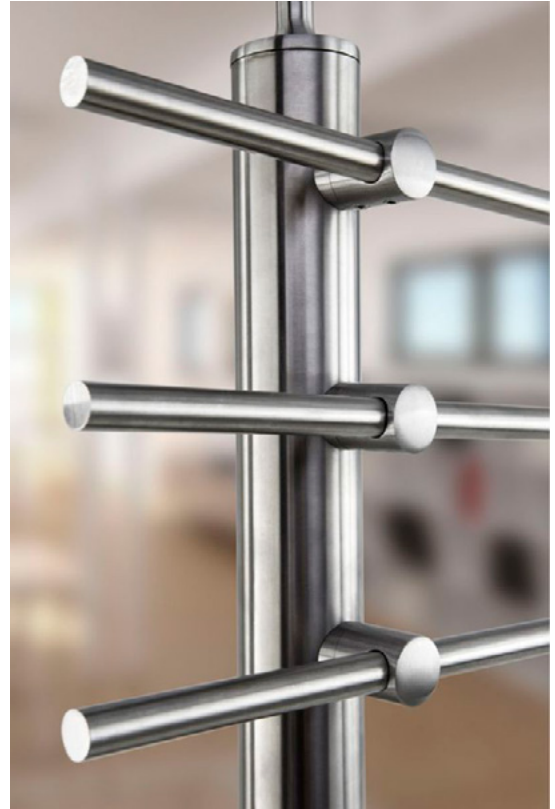

Soportes laterales para tubo



ANILLO DOBLE SOPORTE PARA TUBO REDONDO LATERAL - FIJACIÓN A PARED

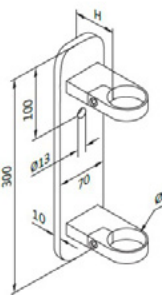

MEDIDAS EN MM

CÓDIGO	DIÁMETRO	H	CANTIDAD
SS-2107	43	45	1
SS-2108	50,8	60	1

SOPORTE PARA TUBO LATERAL - FIJACIÓN A PARED

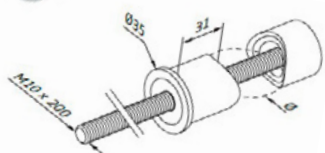

MEDIDAS EN MM

CÓDIGO	DIÁMETRO	CANTIDAD
SS-2109	43 - 50,8	1

Placas fijación y valonas

CONJUNTO PARA TUBO REDONDO

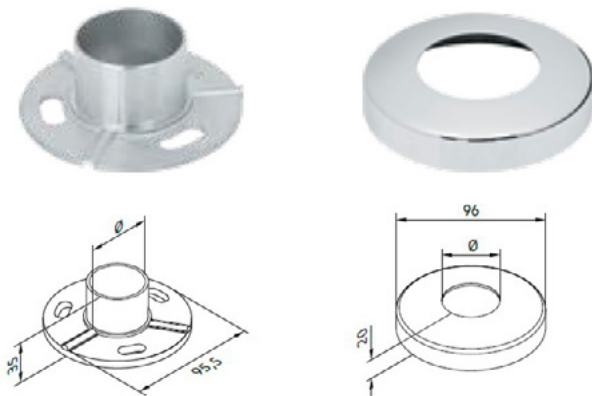

MEDIDAS EN MM

CÓDIGO	PARA TUBO	CANTIDAD
SS-2301	43	2
SS-2302	50,8	2

- VALONA INCLUIDA

CONJUNTO PARA TUBO CUADRADO

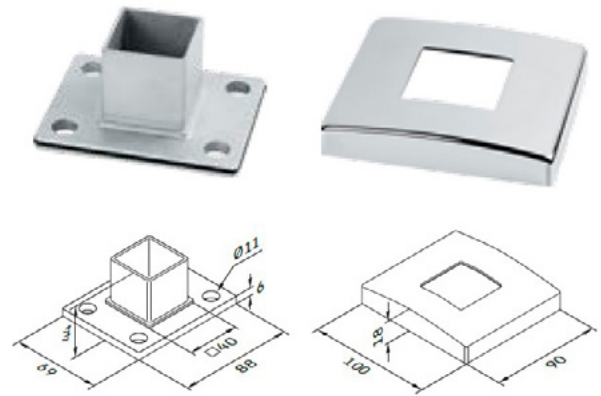

MEDIDAS EN MM

CÓDIGO	PARA TUBO	CANTIDAD
SS-2303	40 x 40	2

- VALONA INCLUIDA

PLACA BASE CUADRADA FIJACIÓN A SUELO

MEDIDAS EN MM

CÓDIGO	PARA TUBO	ESPESOR	CANTIDAD
SS-2304	40 x 40	4	20
SS-2305	50 x 50	4	20

- ACABADO 2B

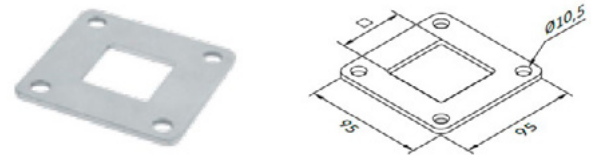

VALONAS CUADRADA PARA PLACA DE FIJACIÓN

MEDIDAS EN MM

CÓDIGO	PARA TUBO	H	CANTIDAD
SS-2306	30 x 30	15	20
SS-2307	40 x 40	15	40
SS-2308	50 X 50	15	40
SS-2309	40 X 20	15	20

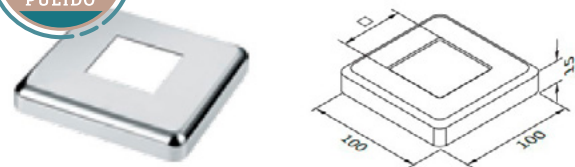

PLACA PARA TUBO REDONDO FIJACIÓN A SUELO

MEDIDAS EN MM

CÓDIGO	PARA TUBO	DIÁMETRO	CANTIDAD
SS-2310	43	96,5	20
SS-2311	50,8	96,5	20

- ACABADO 2B



Valonas

VALONAS REDONDAS PARA PLACA DE FIJACIÓN, CON ACABADO PLANO.

CÓDIGO	REDONDO	DIÁMETRO	MEDIDAS EN MM	
			H	CANTIDAD
SS-2512	12	65	17	20
SS-2516	16	65	17	20
SS-2518	18	65	17	20
SS-2520	20	65	17	20
SS-2525	25	65	17	20
SS-2530	30	65	17	20
SS-2538	38	100,5	17	20
SS-2540	40	100,5	17	20
SS-2543	43	100,5	17	40
SS-2550	50,8	100,5	17	40
SS-2563	63,5	100,5	17	20

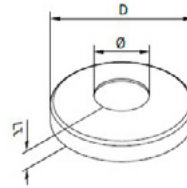

VALONA REDONDA PARA PLETINA, CON ACABADO SEMIESFÉRICO.

CÓDIGO	A x B	DIÁMETRO	MEDIDAS EN MM	
			H	CANTIDAD
SS-2565	40 x 10	108	15	20
SS-2570	50 x 10	108	15	40

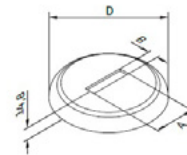

Perfiles de aluminio anodizados

FIJACIÓN A SUELO PARA VIDRIO 12.4/6+6.4/8+8.4/10+10.4

CÓDIGO	MEDIDA
SS-3001	12 x 300 cm
SS-3002	12 x 600 cm

- GOMAS, CUÑAS Y CALZOS INCLUIDOS.

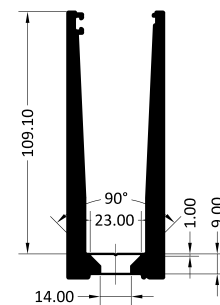

FIJACIÓN LATERAL PARA VIDRIO 12.4/6+6.4/8+8.4/10+10.4

CÓDIGO	MEDIDA
SS-3003	12 x 300 cm
SS-3004	12 x 600 cm

- GOMAS, CUÑAS Y CALZOS INCLUIDOS.

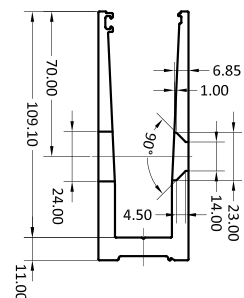

TAPA FIJACIÓN LATERAL

CÓDIGO	MEDIDA
SS-3005	12 x 300 cm
SS-3006	12 x 600 cm







SHANYI
STEEL IBÉRICA

www.shanyisteel.com

 +34 642 67 50 90

shanyisteel@gmail.com

Polígono 18 Parcela 62 - Arambeles
Apartado de correos 82 (45600)
Talavera de la Reina - Toledo (España)